





## 08 *beads*

Crystal Beads are very popular and easy to use. They are available in the latest fashion colours, effects and cuts. Used in a variety of applications (beading, sewing, wire work, etc.), they blend perfectly with other crystal elements. They are available as loose elements, or linked as Bead Chains (please see Cupchains & Findings assortment).

*beads*

COLOURS & EFFECTS

## Colours



## Effects



## Numerical Order

001	Crystal	208	Siam	243	Capri Blue	362	Light Peach
001 AB	Crystal Aurore Boreale	209	Rose	246	Light Colorado Topaz	371	Violet
001 AB2	Crystal Aurore Boreale 2x	211	Light Sapphire	248	Sun	374	Indian Red
001 BBL	Crystal Bermuda Blue	212	Light Amethyst	249	Citrine	379	Indicolite
001 CAL	Crystal Comet Argent Light	213	Jonquil	267	Turquoise	383	Light Grey Opal
001 COP	Crystal Copper	214	Peridot	277	Purple Velvet	385	Lime
001 DOR2	Crystal Dorado 2x	215	Black Diamond	280	Jet	389	Violet Opal
001 GSHA	Crystal Golden Shadow	217	Indian Sapphire	280 HEM	Jet Hematite	390	Pacific Opal
001 HEL	Crystal Heliotrope	220	Smoked Topaz	280 HEM2	Jet Hematite 2x	391	Silk
001 MAT	Crystal Matt Finish*	221	Light Smoked Topaz	280 NUT2	Jet Nut 2x	393	Palace Green Opal
001 METBL2	Crystal Metallic Blue 2x	223	Light Rose	281	White Alabaster	394	Caribbean Blue Opal
001 MLG2	Crystal Metallic Light Gold 2x	225	Smoky Quartz	283	Provence Lavender	395	Rose Water Opal
001 MOL	Crystal Moonlight	226	Light Topaz	284	Greige	396	Dark Red Coral
001 REDM	Crystal Red Magma	227	Light Siam	285	Air Blue Opal	397	Mint Alabaster
001 SAT	Crystal Satin	228	Olivine	286	Mocca	398	Cyclamen Opal
001 SSHA	Crystal Silver Shade	229	Blue Zircon	287	Sand Opal	501	Ruby
001 VM	Crystal Vitrail Medium	234	White Opal	288	Dark Indigo	502	Fuchsia
202	Aquamarine	234 SBL	White Opal Sky Blue*	289	Indian Pink	508	Rosaline
203	Topaz	234 STS	White Opal Star Shine*	291	Fern Green	515	Burgundy
204	Amethyst	236	Hyacinth	293	Rose Alabaster	539	Tanzanite
205	Emerald	237	Fireopal	319	Vintage Rose	542	Padparadscha
206	Sapphire	238	Chrysolite	360	Erinite	550	Khaki
207	Montana	241	Garnet	361	Light Azure		

## Alphabetical Order

<a href="#">Air Blue Opal (285)</a>	<a href="#">Crystal Red Magma (001 REDM)</a>	<a href="#">Jonquil (213)</a>	<a href="#">Rosaline (508)</a>
<a href="#">Amethyst (204)</a>	<a href="#">Crystal Satin (001 SAT)</a>	<a href="#">Khaki (550)</a>	<a href="#">Rose (209)</a>
<a href="#">Aquamarine (202)</a>	<a href="#">Crystal Silver Shade (001 SSHA)</a>	<a href="#">Light Amethyst (212)</a>	<a href="#">Rose Alabaster (293)</a>
<a href="#">Black Diamond (215)</a>	<a href="#">Crystal Vitrail Medium (001 VM)</a>	<a href="#">Light Azure (361)</a>	<a href="#">Rose Water Opal (395)</a>
<a href="#">Blue Zircon (229)</a>	<a href="#">Cyclamen Opal (398)</a>	<a href="#">Light Colorado Topaz (246)</a>	<a href="#">Ruby (501)</a>
<a href="#">Burgundy (515)</a>	<a href="#">Dark Indigo (288)</a>	<a href="#">Light Grey Opal (383)</a>	<a href="#">Sand Opal (287)</a>
<a href="#">Capri Blue (243)</a>	<a href="#">Dark Red Coral (396)</a>	<a href="#">Light Peach (362)</a>	<a href="#">Sapphire (206)</a>
<a href="#">Caribbean Blue Opal (394)</a>	<a href="#">Emerald (205)</a>	<a href="#">Light Rose (223)</a>	<a href="#">Siam (208)</a>
<a href="#">Citrine (249)</a>	<a href="#">Erinite (360)</a>	<a href="#">Light Sapphire (211)</a>	<a href="#">Silk (391)</a>
<a href="#">Chrysolite (238)</a>	<a href="#">Fern Green (291)</a>	<a href="#">Light Siam (227)</a>	<a href="#">Smoked Topaz (220)</a>
<a href="#">Crystal (001)</a>	<a href="#">Fireopal (237)</a>	<a href="#">Light Smoked Topaz (221)</a>	<a href="#">Smoky Quartz (225)</a>
<a href="#">Crystal Aurore Boreale (001 AB)</a>	<a href="#">Fuchsia (502)</a>	<a href="#">Light Topaz (226)</a>	<a href="#">Sun (248)</a>
<a href="#">Crystal Aurore Boreale 2x (001 AB2)</a>	<a href="#">Garnet (241)</a>	<a href="#">Lime (385)</a>	<a href="#">Tanzanite (539)</a>
<a href="#">Crystal Bermuda Blue (001 BBL)</a>	<a href="#">Greige (284)</a>	<a href="#">Mint Alabaster (397)</a>	<a href="#">Topaz (203)</a>
<a href="#">Crystal Comet Argent Light (001 CAL)</a>	<a href="#">Hyacinth (236)</a>	<a href="#">Mocca (286)</a>	<a href="#">Turquoise (267)</a>
<a href="#">Crystal Copper (001 COP)</a>	<a href="#">Indian Pink (289)</a>	<a href="#">Montana (207)</a>	<a href="#">Vintage Rose (319)</a>
<a href="#">Crystal Dorado 2x (001 DOR2)</a>	<a href="#">Indian Red (374)</a>	<a href="#">Olivine (228)</a>	<a href="#">Violet (371)</a>
<a href="#">Crystal Golden Shadow (001 GSHA)</a>	<a href="#">Indian Sapphire (217)</a>	<a href="#">Pacific Opal (390)</a>	<a href="#">Violet Opal (389)</a>
<a href="#">Crystal Heliotrope (001 HEL)</a>	<a href="#">Indicolite (379)</a>	<a href="#">Padparadscha (542)</a>	<a href="#">White Alabaster (281)</a>
<a href="#">Crystal Matt Finish* (001 MAT)</a>	<a href="#">Jet (280)</a>	<a href="#">Palace Green Opal (393)</a>	<a href="#">White Opal (234)</a>
<a href="#">Crystal Metallic Blue 2x (001 METBL2)</a>	<a href="#">Jet Hematite (280 HEM)</a>	<a href="#">Peridot (214)</a>	<a href="#">White Opal Sky Blue* (234 SBL)</a>
<a href="#">Crystal Metallic Light Gold 2x (001 MLG2)</a>	<a href="#">Jet Hematite 2x (280 HEM2)</a>	<a href="#">Provence Lavender (283)</a>	<a href="#">White Opal Star Shine* (234 STS)</a>
<a href="#">Crystal Moonlight (001 MOL)</a>	<a href="#">Jet Nut 2x (280 NUT2)</a>	<a href="#">Purple Velvet (277)</a>	

Classic Colours: This colour range offers a wide choice of traditional Swarovski crystal colours.  
 Exclusive Colours: This colour range is offered exclusively by Swarovski.

Slight changes in shades are unavoidable.

The plating resistance of effects is tested according to Swarovski's plating guidelines (WWW.SWAROVSKI-ELEMENTS.COM/BUSINESS). Customers are advised to carry out their own tests if customers' plating parameters diverge from Swarovski plating guidelines.

\* Colours are only available as special productions.

## Summary

<<<

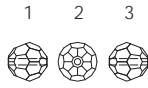

**5000**  
2, 3, 4, 5, 6, 7, 8, 10,  
12, 14, 16, 18, 20 mm

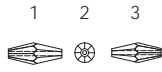

**5205**  
15x6 mm

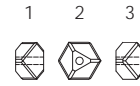

**5600**  
4, 6, 8 mm



**5003**  
6, 8, 10, 12, 14, 16 mm



**5305**  
5, 6 mm

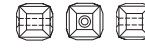

**5601**  
4, 6, 8, 10, 12 mm



**5005**  
8, 12, 16 mm



**5308**  
6, 8 mm

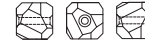

**5603**  
4, 6, 8, 10 mm



**5015**  
3, 4 mm

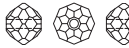

**5309/1**  
4, 6, 8 mm



**5621**  
14, 18, 22 mm



**5020**  
4, 6, 8, 10, 12 mm



**5328**  
2.5, 3, 4, 5, 6, 8, 10 mm



**5650**  
12x8, 16x10,  
20x13.5, 28x18.5 mm



**5040**  
4, 6, 8, 12, 18 mm



**5500**  
9x6, 10.5x7,  
12x8, 18x12 mm



**5714**  
8, 12 mm



**5041**  
12, 18 mm



**5520**  
12, 18 mm



**5727**  
14, 18 mm



**5139**  
12.5 mm



**5523**  
12, 16 mm



**5742**  
8, 10, 14 mm



**5150**  
11x6, 15x7, 23x11 mm



**5530**  
18, 28, 36 mm



**5744**  
6, 8 mm



**5180**  
14x14 mm



**5531**  
18, 28, 36 mm



**5754**  
6, 8, 10, 12 mm



**5181**  
13x7, 17x9 mm



**5540**  
12, 17 mm



**5200**  
6x4, 7.5x5, 9x6 mm



**5556**  
11x19, 13.5x24, 15x27 mm



**5203**  
12x8, 18x12 mm



**5590**  
7.5x18, 10x23 mm

# Beads

5000

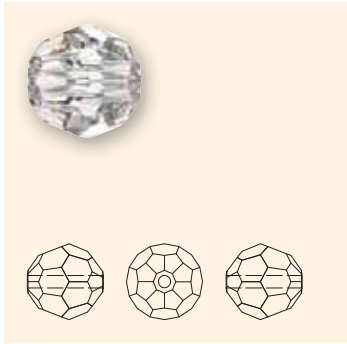

Size	2 mm	3 mm	4 mm	5 mm	6 mm	7 mm	8 mm	10 mm	12 mm	14 mm	16 mm	18 mm	20 mm
------	------	------	------	------	------	------	------	-------	-------	-------	-------	-------	-------

## Colour

Crystal (001)	■	■	■	■	■	■	■	■	■	■	■	■	■
Crystal AB (001 AB)	■	■	■	■	■	■	■	■	■	■	■	■	■
Crystal AB 2x (001 AB2)			■	■	■	■	■	■	■	■	■	■	■
Crystal Copper (001 COP)	■	■	■	■	■	■	■	■	■	■	■	■	■
Crystal Dorado (001 DOR)			■	■	■	■	■	■	■	■	■	■	■
Crystal Dorado 2x (001 DOR2)			■	■	■	■	■	■	■	■	■	■	■
Crystal Golden Shadow (001 GSHA)	■	■	■	■	■	■	■	■	■	■	■	■	■
Crystal Metallic Blue (001 METBL)		■	■	■	■	■	■	■	■	■	■	■	■
Crystal Metallic Light Gold 2x (001 MLG2)			■	■	■	■	■	■	■	■	■	■	■
Crystal Moonlight (001 MOL)	■	■	■	■	■	■	■	■	■	■	■	■	■
Crystal Red Magma (001 REDM)		■	■	■	■	■	■	■	■	■	■	■	■
Crystal Satin (001 SAT)			■	■	■	■	■	■	■	■	■	■	■
Crystal Silver Shade (001 SSHA)	■	■	■	■	■	■	■	■	■	■	■	■	■
Crystal Vitrail Medium (001 VM)		■	■	■	■	■	■	■	■	■	■	■	■
Jet (280)	■	■	■	■	■	■	■	■	■	■	■	■	■
Jet AB (280 AB)		■	■	■	■	■	■	■	■	■	■	■	■
Jet Hematite (280 HEM)		■	■	■	■	■	■	■	■	■	■	■	■
Jet Hematite 2x (280 HEM2)		■	■	■	■	■	■	■	■	■	■	■	■
Jet Nut (280 NUT)			■	■	■	■	■	■	■	■	■	■	■
Jet Nut 2x (280 NUT2)			■	■	■	■	■	■	■	■	■	■	■
Air Blue Opal (285)	■	■	■	■	■	■	■	■	■	■	■	■	■
Amethyst (204)	■	■	■	■	■	■	■	■	■	■	■	■	■
Amethyst AB (204 AB)			■	■	■	■	■	■	■	■	■	■	■
Aquamarine (202)	■	■	■	■	■	■	■	■	■	■	■	■	■
Aquamarine AB (202 AB)			■	■	■	■	■	■	■	■	■	■	■
Black Diamond (215)	■	■	■	■	■	■	■	■	■	■	■	■	■
Black Diamond AB (215 AB)			■	■	■	■	■	■	■	■	■	■	■
Blue Zircon (229)			■	■	■	■	■	■	■	■	■	■	■
Blue Zircon AB (229 AB)			■	■	■	■	■	■	■	■	■	■	■
Burgundy (515)			■	■	■	■	■	■	■	■	■	■	■
Capri Blue (243)	■	■	■	■	■	■	■	■	■	■	■	■	■
Capri Blue AB (243 AB)			■	■	■	■	■	■	■	■	■	■	■
Caribbean Blue Opal (394)		■	■	■	■	■	■	■	■	■	■	■	■
Chrysolite (238)			■	■	■	■	■	■	■	■	■	■	■
Chrysolite AB (238 AB)			■	■	■	■	■	■	■	■	■	■	■
Cyclamen Opal (398)	■	■	■	■	■	■	■	■	■	■	■	■	■
Dark Indigo (288)	■	■	■	■	■	■	■	■	■	■	■	■	■
Dark Red Coral (396)		■	■	■	■	■	■	■	■	■	■	■	■
Emerald (205)	■	■	■	■	■	■	■	■	■	■	■	■	■

Beads

# Beads

5000	Size												
	2 mm	3 mm	4 mm	5 mm	6 mm	7 mm	8 mm	10 mm	12 mm	14 mm	16 mm	18 mm	20 mm
Emerald AB (205 AB)			■		■		■						
Erinite (360)		■	■		■		■						
Erinite AB (360 AB)			■		■		■						
Fern Green (291)		■	■		■		■						
Fireopal (237)			■		■		■						
Fireopal AB (237 AB)					■		■						
Fuchsia (502)	■	■	■	■	■		■	■					
Fuchsia AB (502 AB)			■		■		■						
Garnet (241)			■		■		■		■				
Greige (284)	■	■	■		■		■		■				
Hyacinth (236)	■	■	■		■		■						
Hyacinth AB (236 AB)			■		■		■						
Indian Pink (289)	■	■	■		■		■						
Indian Red (374)			■		■		■						
Indian Sapphire (217)			■		■		■						
Indian Sapphire AB (217 AB)			■		■		■						
Indicolite (379)		■	■		■		■						
Indicolite AB (379 AB)			■		■		■						
Jonquil (213)	■	■	■	■	■		■	■					
Jonquil AB (213 AB)			■		■		■		■				
Khaki (550)			■		■		■						
Light Amethyst (212)	■	■	■	■	■		■	■					
Light Amethyst AB (212 AB)			■		■		■		■				
Light Azore (361)	■	■	■		■		■						
Light Colorado Topaz (246)	■	■	■	■	■		■	■	■	■			
Light Colorado Topaz AB (246 AB)			■		■		■		■				
Light Grey Opal (383)		■	■		■		■						
Light Peach (362)			■		■		■						
Light Peach AB (362 AB)			■		■		■						
Light Rose (223)	■	■	■	■	■		■	■	■	■			
Light Rose AB (223 AB)			■		■		■		■				
Light Sapphire (211)	■	■	■		■		■		■				
Light Sapphire AB (211 AB)			■		■		■		■				
Light Siam (227)	■	■	■	■	■		■	■					
Light Siam AB (227 AB)			■		■		■		■				
Light Smoked Topaz (221)			■		■		■						
Light Smoked Topaz AB (221 AB)			■		■		■						
Light Topaz (226)		■	■		■		■	■	■	■			
Light Topaz AB (226 AB)			■		■		■		■				
Lime (385)			■		■		■						



# Beads

## 5003

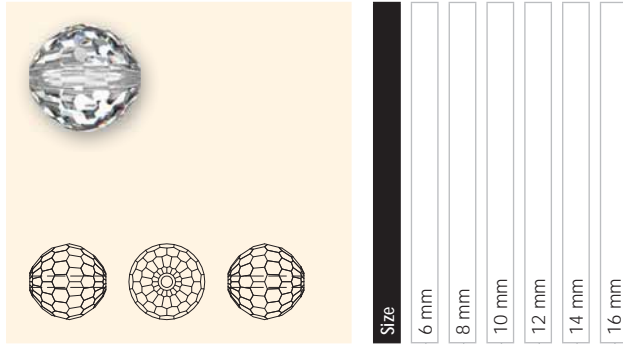

Colour	6 mm	8 mm	10 mm	12 mm	14 mm	16 mm
Crystal (001)	■	■	■	■	■	■
Crystal AB (001 AB)	■	■	■	■	■	■

## 5005 Chessboard Bead

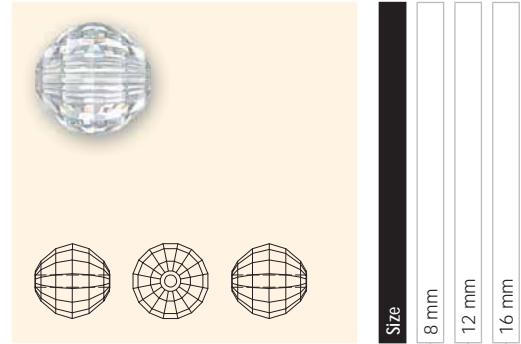

Colour	8 mm	12 mm	16 mm
Crystal (001)	■	■	■
Crystal AB (001 AB)	■	■	■
Crystal Copper (001 COP)	■	■	■
Crystal Golden Shadow (001 GSHA)	■	■	■
Crystal Red Magma (001 REDM)	■	■	■
Crystal Silver Shade (001 SSHA)	■	■	■
Jet (280)	■	■	■
Aquamarine (202)	■	■	
Light Rose (223)	■	■	
Light Topaz (226)	■	■	
Peridot (214)	■	■	
Tanzanite (539)	■	■	

## 5015

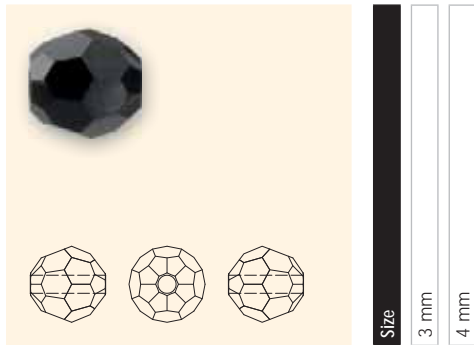

Colour	3 mm	4 mm
Jet (280)	■	■
Jet Hematite 2x (280 HEM2)	■	■

# Beads

## 5020 Helix Bead

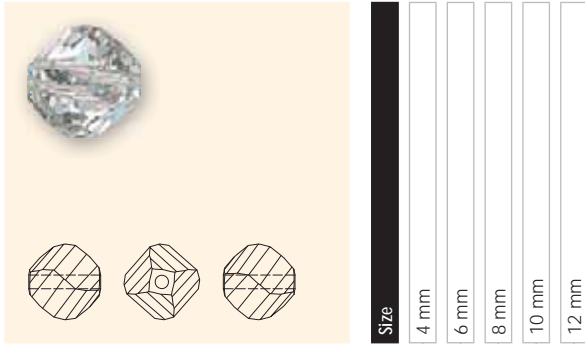

Colour	4 mm	6 mm	8 mm	10 mm	12 mm
Crystal (001)	■	■	■	■	■
Crystal AB (001 AB)	■	■	■	■	■
Crystal Copper (001 COP)		■	■	■	■
Crystal Golden Shadow (001 GSHA)		■	■	■	■
Crystal Silver Shade (001 SSHA)		■	■	■	■
Jet (280)		■	■	■	■
Aquamarine (202)			■	■	
Black Diamond (215)			■	■	
Light Rose (223)			■	■	
Peridot (214)			■	■	
Siam (208)			■	■	
Topaz (203)			■	■	

## 5040 Briolette Bead

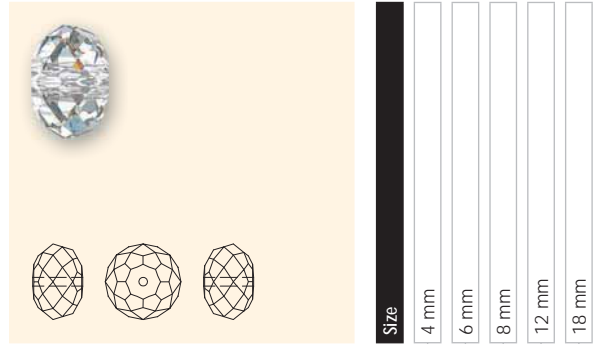

Colour	4 mm	6 mm	8 mm	12 mm	18 mm
Crystal (001)	■	■	■	■	■
Crystal AB (001 AB)	■	■	■	■	■
Crystal Copper (001 COP)		■	■	■	■
Crystal Golden Shadow (001 GSHA)		■	■	■	■
Crystal Moonlight (001 MOL)		■	■	■	■
Crystal Metallic Light Gold 2x (001 MLG2)		■	■	■	■
Crystal Red Magma (001 REDM)		■	■	■	■
Crystal Silver Shade (001 SSHA)		■	■	■	■
Jet (280)		■	■	■	■
Air Blue Opal (285)			■	■	■
Amethyst (204)	■	■	■	■	■
Amethyst AB(204 AB)	■	■	■	■	■
Aquamarine (202)	■	■	■	■	■
Aquamarine AB(202 AB)	■	■	■	■	■
Black Diamond (215)	■	■	■	■	■
Black Diamond AB (215 AB)	■	■	■	■	■
Caribbean Blue Opal (394)		■	■	■	■
Cyclamen Opal (398)		■	■	■	■
Dark Indigo (288)		■	■	■	■
Erinite (360)		■	■	■	■
Erinite AB (360 AB)		■	■	■	■
Fern Green (291)		■	■	■	■
Greige (284)		■	■	■	■
Indian Pink (289)		■	■	■	■
Indicolite (379)		■	■	■	■
Jonquil (213)		■	■	■	■
Jonquil AB (213 AB)		■	■	■	■
Khaki (550)		■	■	■	■
Light Colorado Topaz (246)	■	■	■	■	■
Light Colorado Topaz AB (246 AB)	■	■	■	■	■
Light Grey Opal (383)		■	■	■	■
Light Rose (223)	■	■	■	■	■
Light Rose AB (223 AB)	■	■	■	■	■
Light Siam (227)	■	■	■	■	■
Light Siam AB (227 AB)	■	■	■	■	■
Light Topaz (226)		■	■	■	■
Mocca (286)		■	■	■	■
Pacific Opal (390)		■	■	■	■
Padparadscha (542)	■	■	■	■	■

Beads

# Beads

**5040**



**Size**

4 mm 6 mm 8 mm 12 mm 18 mm

**Colour**

Padparadscha AB (542 AB)					
Palace Green Opal (393)					
Peridot (214)					
Provence Lavender (283)					
Purple Velvet (277)					
Rose Water Opal (395)					
Sand Opal (287)					
Siam (208)					
Siam AB (208 AB)					
Silk (391)					
Tanzanite (539)					
Tanzanite AB (539 AB)					
Topaz (203)					
Topaz AB (203 AB)					
Vintage Rose (319)					
Violet (371)					
Violet Opal (389)					
White Opal (234)					

## 5041 Briolette Bead (large hole)

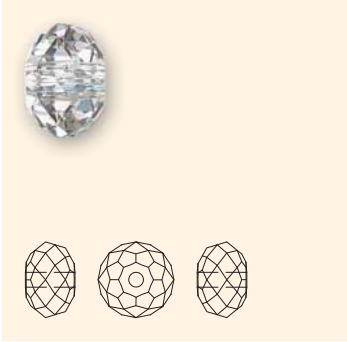

**Size**

12 mm 18 mm

**Colour**

Crystal (001)		
Crystal AB (001 AB)		
Crystal Copper (001 COP)		
Crystal Golden Shadow (001 GSHA)		
Crystal Red Magma (001 REDM)		
Crystal Silver Shade (001 SSHA)		
Jet (280)		

## 5139 Ring Bead

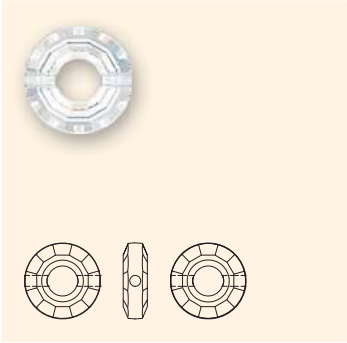

**Size**

12.5 mm

**Colour**

Crystal (001)	
Crystal AB (001 AB)	
Crystal Copper (001 COP)	
Crystal Golden Shadow (001 GSHA)	
Crystal Red Magma (001 REDM)	
Crystal Silver Shade (001 SSHA)	
Jet (280)	
Amethyst (204)	
Aquamarine (202)	
Light Smoked Topaz (221)	
Light Topaz (226)	
Olivine (228)	
Violet (371)	

Ø Beads

# Beads

## 5150 Modular Bead

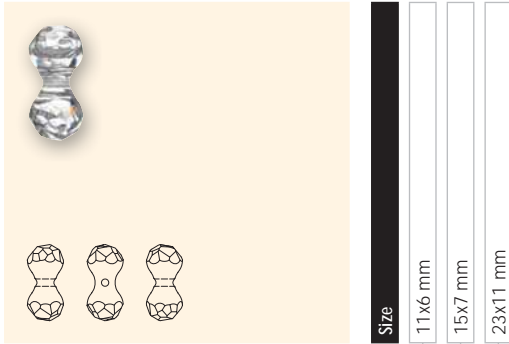

Colour	11x6 mm	15x7 mm	23x11 mm
Crystal (001)	■	■	■
Crystal AB (001 AB)	■	■	■
Crystal Copper (001 COP)	■	■	■
Crystal Golden Shadow (001 GSHA)	■	■	■
Crystal Silver Shade (001 SSHA)	■	■	■
Jet (280)	■	■	■
Aquamarine (202)	■	■	
Black Diamond (215)	■	■	
Fuchsia (502)	■	■	
Light Rose (223)	■	■	
Light Topaz (226)	■	■	
Montana (207)	■	■	
Peridot (214)	■	■	
Siam (208)	■	■	
Tanzanite (539)	■		

## 5180 Square Bead (two holes)

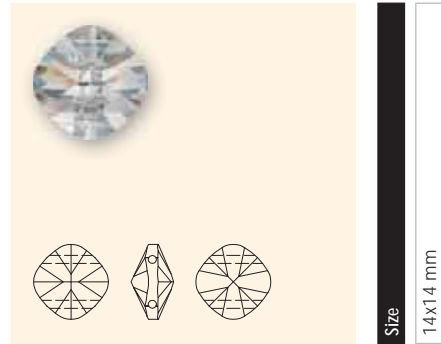

Colour	14x14 mm
Crystal (001)	■
Crystal AB (001 AB)	■
Crystal Copper (001 COP)	■
Crystal Golden Shadow (001 GSHA)	■
Crystal Red Magma (001 REDM)	■
Crystal Silver Shade (001 SSHA)	■
Jet (280)	■
Amethyst (204)	■
Jonquil (213)	■
Rosaline (508)	■
Peridot (214)	■
Light Sapphire (211)	■
Sapphire (206)	■

# Beads

## 5181 Keystone Bead (two holes)

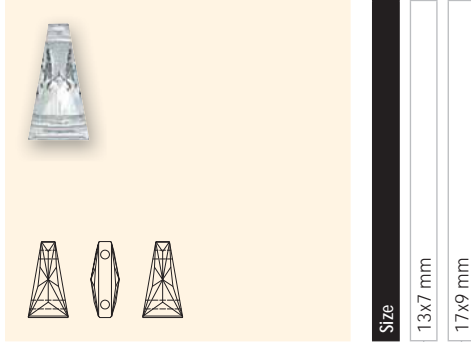

Size	
13x7 mm	17x9 mm

Colour	
Crystal (001)	<input type="checkbox"/>
Crystal AB (001 AB)	<input type="checkbox"/>
Crystal Copper (001 COP)	<input type="checkbox"/>
Crystal Golden Shadow (001 GSHA)	<input type="checkbox"/>
Crystal Red Magma (001 REDM)	<input type="checkbox"/>
Crystal Silver Shade (001 SSHA)	<input type="checkbox"/>
Jet (280)	<input type="checkbox"/>
Amethyst (204)	<input type="checkbox"/>
Aquamarine (202)	<input type="checkbox"/>
Burgundy (515)	<input type="checkbox"/>
Jonquil (213)	<input type="checkbox"/>
Peridot (214)	<input type="checkbox"/>

## 5200

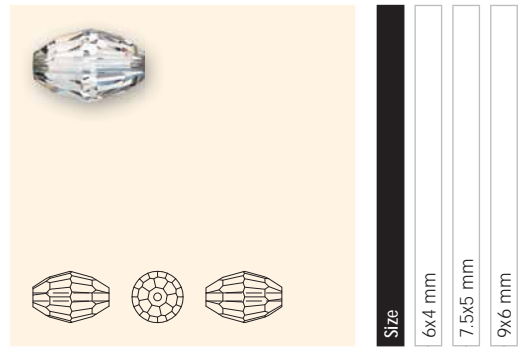

Size	
6x4 mm	7.5x5 mm
	9x6 mm

Colour	
Crystal (001)	<input type="checkbox"/>
Crystal AB (001 AB)	<input type="checkbox"/>
Jet (280)	<input type="checkbox"/>

## 5203 Polygon Bead

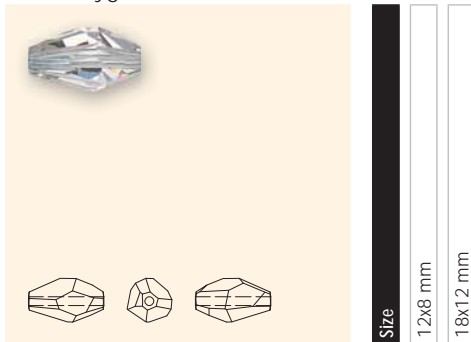

Size	
12x8 mm	18x12 mm

Colour	
Crystal (001)	<input type="checkbox"/>
Crystal AB (001 AB)	<input type="checkbox"/>
Crystal Golden Shadow (001 GSHA)	<input type="checkbox"/>
Jet (280)	<input type="checkbox"/>
Amethyst (204)	<input type="checkbox"/>
Aquamarine (202)	<input type="checkbox"/>
Black Diamond (215)	<input type="checkbox"/>
Light Colorado Topaz (246)	<input type="checkbox"/>
Olivine (228)	<input type="checkbox"/>
Padparadscha (542)	<input type="checkbox"/>
Siam (208)	<input type="checkbox"/>
Smoked Topaz (220)	<input type="checkbox"/>

## 5205

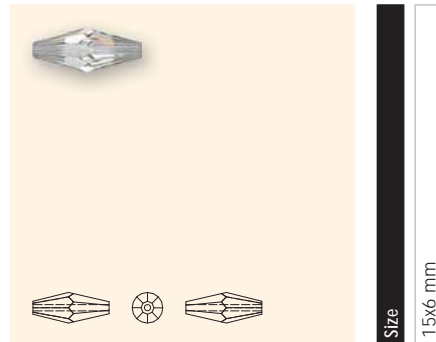

Size	
15x6 mm	

Colour	
Crystal (001)	<input type="checkbox"/>
Crystal AB (001 AB)	<input type="checkbox"/>
Crystal Golden Shadow (001 GSHA)	<input type="checkbox"/>
Crystal Silver Shade (001 SSHA)	<input type="checkbox"/>
Jet (280)	<input type="checkbox"/>

# Beads

5305

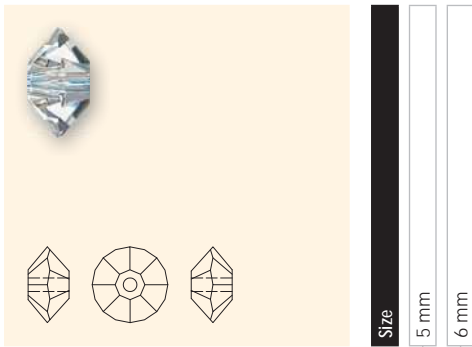

Size
5 mm
6 mm

Colour
Crystal (001)
Crystal AB (001 AB)
Jet (280)

5308

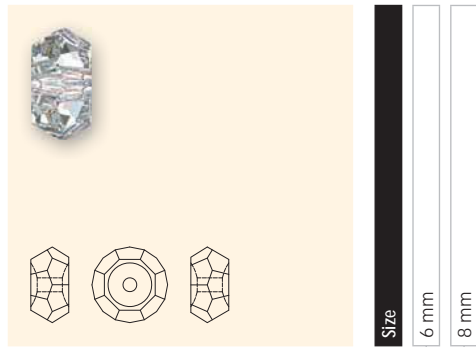

Size
6 mm
8 mm

Colour
Crystal (001)
Crystal AB (001 AB)

5309/1

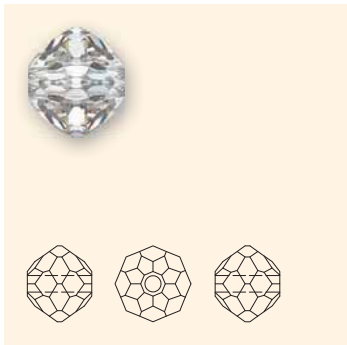

Size
4 mm
6 mm
8 mm

Colour
Crystal (001)
Crystal AB (001 AB)
Crystal Cosmojet (001 COS)

Ø Beads

# Beads

## 5328 XILION Bead

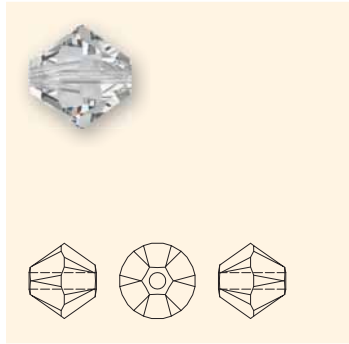

Size	2.5 mm	3 mm	4 mm	5 mm	6 mm	8 mm	10 mm
------	--------	------	------	------	------	------	-------

Colour	2.5 mm	3 mm	4 mm	5 mm	6 mm	8 mm	10 mm
Crystal (001)	■	■	■	■	■	■	■
Crystal AB (001 AB)	■	■	■	■	■	■	■
Crystal AB 2x (001 AB2)		■	■	■	■	■	■
Crystal AB Satin (001 ABSAT)		■	■	■	■	■	■
Crystal CAL (001 CAL)		■	■	■	■	■	■
Crystal Copper (001 COP)	■	■	■	■	■	■	■
Crystal Dorado 2x (001 DOR2)		■	■	■	■	■	■
Crystal Golden Shadow (001 GSHA)	■	■	■	■	■	■	■
Crystal Heliotrope (001 HEL)	■	■	■	■	■	■	■
Crystal Moonlight (001 MOL)	■	■	■	■	■	■	■
Crystal Metallic Blue 2x (001 METBL2)	■	■	■	■	■	■	■
Crystal Metallic Light Gold 2x (001 MLG2)	■	■	■	■	■	■	■
Crystal Red Magma (001 REDM)	■	■	■	■	■	■	■
Crystal Satin (001 SAT)	■	■	■	■	■	■	■
Crystal Silver Shade (001 SSHA)	■	■	■	■	■	■	■
Crystal Vitrail Medium (001 VM)	■	■	■	■	■	■	■
Jet (280)	■	■	■	■	■	■	■
Jet AB (280 AB)	■	■	■	■	■	■	■
Jet AB 2x (280 AB2)		■	■	■	■	■	■
Jet Hematite (280 HEM)	■	■	■	■	■	■	■
Jet Hematite 2x (280 HEM2)		■	■	■	■	■	■
Jet Nut 2x (280 NUT2)		■	■	■	■	■	■
Air Blue Opal (285)	■	■	■	■	■	■	■
Amethyst (204)	■	■	■	■	■	■	■
Amethyst AB (204 AB)		■	■	■	■	■	■
Amethyst AB 2x (204 AB2)			■	■	■	■	■
Amethyst Satin (204 SAT)			■	■	■	■	■
Aquamarine (202)	■	■	■	■	■	■	■
Aquamarine AB (202 AB)		■	■	■	■	■	■
Aquamarine AB 2x (202 AB2)			■	■	■	■	■
Aquamarine Satin (202 SAT)			■	■	■	■	■
Black Diamond (215)	■	■	■	■	■	■	■
Black Diamond AB (215 AB)		■	■	■	■	■	■
Black Diamond AB 2x (215 AB2)			■	■	■	■	■
Black Diamond Satin (215 SAT)			■	■	■	■	■
Blue Zircon (229)	■	■	■	■	■	■	■
Blue Zircon AB (229 AB)			■	■	■	■	■
Blue Zircon AB 2x (229 AB2)				■	■	■	■
Burgundy (515)	■	■	■	■	■	■	■



Size	2.5 mm	3 mm	4 mm	5 mm	6 mm	8 mm	10 mm
------	--------	------	------	------	------	------	-------

Colour	2.5 mm	3 mm	4 mm	5 mm	6 mm	8 mm	10 mm
Burgundy AB (515 AB)			■				
Capri Blue (243)		■	■	■	■	■	■
Capri Blue AB (243 AB)		■	■	■	■	■	■
Capri Blue AB 2x (243 AB2)			■	■	■	■	■
Capri Blue Satin (243 SAT)			■	■	■	■	■
Caribbean Blue Opal (394)		■	■	■	■	■	■
Caribbean Blue Opal AB (394 AB)			■	■	■	■	■
Citrine (249)		■	■	■	■	■	■
Citrine AB (249 AB)			■	■	■	■	■
Chrysolite (238)		■	■	■	■	■	■
Chrysolite AB (238 AB)		■	■	■	■	■	■
Chrysolite AB 2x (238 AB2)			■	■	■	■	■
Chrysolite Satin (238 SAT)			■	■	■	■	■
Cyclamen Opal (398)		■	■	■	■	■	■
Dark Indigo (288)	■	■	■	■	■	■	■
Dark Red Coral (396)		■	■	■	■	■	■
Dark Red Coral AB (396 AB)			■	■	■	■	■
Emerald (205)	■	■	■	■	■	■	■
Emerald AB (205 AB)		■	■	■	■	■	■
Emerald AB 2x (205 AB2)			■	■	■	■	■
Emerald Satin (205 SAT)			■	■	■	■	■
Erinite (360)		■	■	■	■	■	■
Erinite AB (360 AB)			■	■	■	■	■
Fern Green (291)		■	■	■	■	■	■
Fireopal (237)			■	■	■	■	■
Fireopal AB (237 AB)			■	■	■	■	■
Fireopal AB 2x (237 AB2)				■	■	■	■
Fuchsia (502)	■	■	■	■	■	■	■
Fuchsia AB (502 AB)		■	■	■	■	■	■
Fuchsia AB 2x (502 AB2)			■	■	■	■	■
Fuchsia Satin (502 SAT)			■	■	■	■	■
Garnet (241)		■	■	■	■	■	■
Garnet AB (241 AB)			■	■	■	■	■
Garnet AB 2x (241 AB2)				■	■	■	■
Greige (284)		■	■	■	■	■	■
Hyacinth (236)		■	■	■	■	■	■
Hyacinth AB (236 AB)		■	■	■	■	■	■
Hyacinth AB 2x (236 AB2)			■	■	■	■	■
Hyacinth Satin (236 SAT)			■	■	■	■	■
Indian Pink (289)		■	■	■	■	■	■

Ø Beads

# Beads

5328

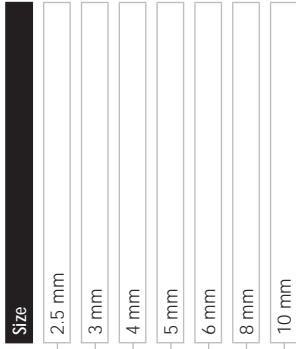

**Colour**

Indian Pink AB (289 AB) <i>New!</i>							
Indian Red (374)							
Indian Red AB (374 AB)							
Indian Red Satin (374 SAT)							
Indian Sapphire (217)							
Indian Sapphire AB (217 AB)							
Indicolite (379)							
Indicolite AB (379 AB)							
Indicolite AB 2x (379 AB2) <i>New!</i>							
Indicolite Satin (379 SAT)							
Jonquill (213)							
Jonquill AB (213 AB)							
Jonquill AB 2x (213 AB2)							
Jonquill Satin (213 SAT)							
Khaki (550)							
Light Amethyst (212)							
Light Amethyst AB (212 AB)							
Light Amethyst AB 2x (212 AB2)							
Light Amethyst Satin (212 SAT)							
Light Azure (361)							
Light Azure AB (361 AB)							
Light Azure AB 2x (361 AB2)							
Light Azure Satin (361 SAT)							
Light Colorado Topaz (246)							
Light Colorado Topaz AB (246 AB)							
Light Colorado Topaz AB 2x (246 AB2)							
Light Colorado Topaz Satin (246 SAT)							
Light Grey Opal (383)							
Light Peach (362)							
Light Peach AB (362 AB)							
Light Peach AB 2x (362 AB2)							
Light Peach Satin (362 SAT)							
Light Rose (223)							
Light Rose AB (223 AB)							
Light Rose AB 2x (223 AB2)							
Light Rose Satin (223 SAT)							
Light Sapphire (211)							
Light Sapphire AB (211 AB)							
Light Sapphire AB 2x (211 AB2)							
Light Sapphire Satin (211 SAT)							

5328

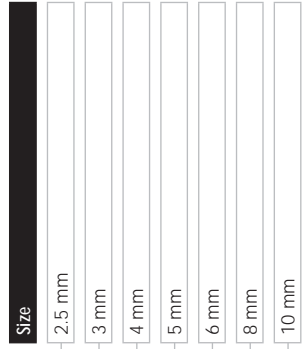

**Colour**

Light Siam (227)							
Light Siam AB (227 AB)							
Light Siam AB 2x (227 AB2)							
Light Siam Satin (227 SAT)							
Light Smoked Topaz (221)							
Light Smoked Topaz AB (221 AB)							
Light Smoked Topaz AB 2x (221 AB2) <i>New!</i>							
Light Smoked Topaz Satin (221 SAT)							
Light Topaz (226)							
Light Topaz AB (226 AB)							
Light Topaz AB 2x (226 AB2) <i>New!</i>							
Lime (385)							
Lime AB (385 AB)							
Mint Alabaster (397)							
Mint Alabaster AB (397 AB)							
Mint Alabaster AB 2x (397 AB2) <i>New!</i>							
Mocca (286)							
Mocca AB 2x (286 AB2) <i>New!</i>							
Montana (207)							
Montana AB (207 AB)							
Montana AB 2x (207 AB2)							
Montana Satin (207 SAT)							
Olivine (228)							
Olivine AB (228 AB)							
Olivine AB 2x (228 AB2)							
Olivine Satin (228 SAT)							
Pacific Opal (390)							
Pacific Opal AB 2x (390 AB2) <i>New!</i>							
Padparadscha (542)							
Padparadscha AB (542 AB)							
Padparadscha AB 2x (542 AB2)							
Padparadscha Satin (542 SAT)							
Palace Green Opal (393)							
Peridot (214)							
Peridot AB (214 AB)							
Peridot AB 2x (214 AB2)							
Peridot Satin (214 SAT)							
Provence Lavender (283)							
Purple Velvet (277)							
Purple Velvet AB (277 AB)							

# Beads

5328		Size	2.5 mm	3 mm	4 mm	5 mm	6 mm	8 mm	10 mm
Colour									
Rosaline (508)			■	■	■	■	■	■	
Rosaline AB (508 AB)				■					
Rosaline AB 2x (508 AB2)	New!			■					
Rose (209)		■	■	■	■	■	■	■	■
Rose AB (209 AB)			■	■	■	■	■	■	
Rose AB 2x (209 AB2)				■					
Rose Satin (209 SAT)				■					
Rose Alabaster (293)			■	■	■	■			
Rose Alabaster AB (293 AB)				■					
Rose Water Opal (395)			■	■	■	■	■	■	
Rose Water Opal AB (395 AB)				■					
Rose Water Opal AB 2x (395 AB2)	New!			■					
Ruby (501)			■	■	■	■	■	■	
Ruby AB (501 AB)				■			■		
Ruby AB 2x (501 AB2)	New!			■					
Ruby Satin (501 SAT)				■					
Sand Opal (287)			■	■	■	■			
Sapphire (206)		■	■	■	■	■	■	■	■
Sapphire AB (206 AB)			■	■	■	■			
Sapphire AB 2x (206 AB2)				■					
Sapphire Satin (206 SAT)				■					
Siam (208)		■	■	■	■	■	■	■	■
Siam AB (208 AB)			■	■	■	■			
Siam AB 2x (208 AB2)				■					
Siam Satin (208 SAT)				■					
Silk (391)		■	■	■	■	■			
Silk AB (391 AB)				■					
Smoked Topaz (220)		■	■	■	■	■	■	■	
Smoked Topaz AB (220 AB)				■			■		
Smoked Topaz AB 2x (220 AB2)				■					
Smoky Quartz (225)				■					
Smoky Quartz AB (225 AB)				■					
Smoky Quartz Satin (225 SAT)				■					
Sun (248)			■	■	■	■	■	■	
Sun AB (248 AB)				■					
Sun AB 2x (248 AB2)	New!			■					
Tanzanite (539)		■	■	■	■	■	■	■	■
Tanzanite AB (539 AB)			■	■	■	■			
Tanzanite AB 2x (539 AB2)				■					
Topaz (203)		■	■	■	■	■	■	■	■

5328		Size	2.5 mm	3 mm	4 mm	5 mm	6 mm	8 mm	10 mm
Colour									
Topaz AB (203 AB)			■	■	■	■			
Topaz AB 2x (203 AB2)				■					
Topaz Satin (203 SAT)				■					
Turquoise (267)		■	■	■	■	■	■		
Turquoise AB (267 AB)		■	■	■	■	■	■		
Turquoise AB 2x (267 AB2)				■					
Vintage Rose (319)		■	■	■	■	■	■		
Vintage Rose AB (319 AB)				■					
Violet (371)		■	■	■	■	■	■	■	■
Violet AB (371 AB)		■	■	■	■	■	■	■	
Violet AB 2x (371 AB2)				■					
Violet Opal (389)		■	■	■	■	■	■		
White Alabaster (281)		■	■	■	■	■	■		
White Alabaster AB (281 AB)				■					
White Alabaster AB 2x (281 AB2)	New!			■					
White Opal (234)		■	■	■	■	■	■	■	
White Opal AB (234 AB)		■	■	■	■	■	■		
White Opal AB 2x (234 AB2)				■					

Ø Beads

# Beads

## 5500

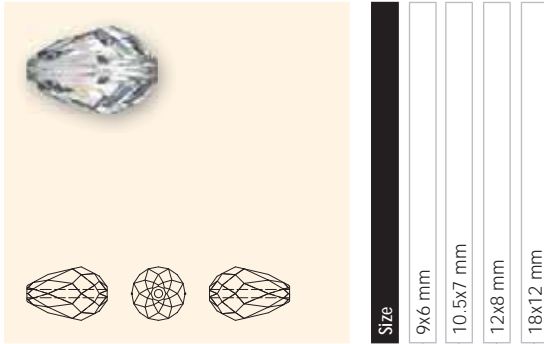

Colour		9x6 mm	10.5x7 mm	12x8 mm	18x12 mm
Crystal (001)		■	■	■	■
Crystal AB (001 AB)		■	■	■	■
Jet (280)		■			
Amethyst (204)		■			
Aquamarine (202)		■			
Black Diamond (215)		■			
Indicolite (379)		■			
Light Colorado Topaz (246)		■			
Peridot (214)		■			
Rose (209)		■			
Siam (208)		■			
Tanzanite (539)		■			
Topaz (203)		■			
Violet (371)		■			

## 5520 Graphic Bead

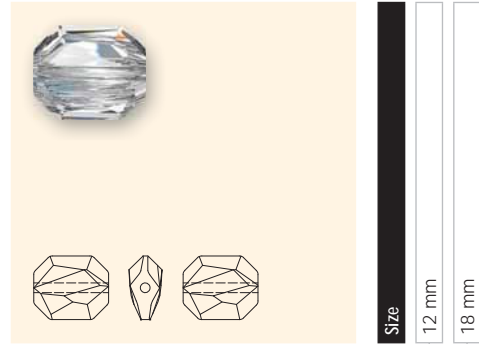

Colour		12 mm	18 mm
Crystal (001)		■	■
Crystal AB (001 AB)		■	■
Crystal Copper (001 COP)		■	■
Crystal Golden Shadow (001 GSHA)		■	■
Crystal Silver Shade (001 SSHA)		■	■
Jet (280)		■	■
Amethyst (204)		■	■
Aquamarine (202)		■	■
Indicolite (379)		■	■
Light Amethyst (212)		■	■
Olivine (228)		■	■
Ruby (501)		■	■

## 5523 Cosmic Bead



Colour		12 mm	16 mm
Crystal (001)		■	■
Crystal AB (001 AB)		■	■
Crystal Copper (001 COP)		■	■
Crystal Golden Shadow (001 GSHA)		■	■
Crystal Red Magma (001 REDM)		■	■
Crystal Silver Shade (001 SSHA)		■	■
Jet (280)		■	■
Amethyst (204)		■	■
Aquamarine (202)		■	■
Fuchsia (502)		■	■
Indicolite (379)		■	■
Light Amethyst (212)		■	■
Olivine (228)		■	■

# Beads

## 5530 Aquiline Bead (center hole)\*

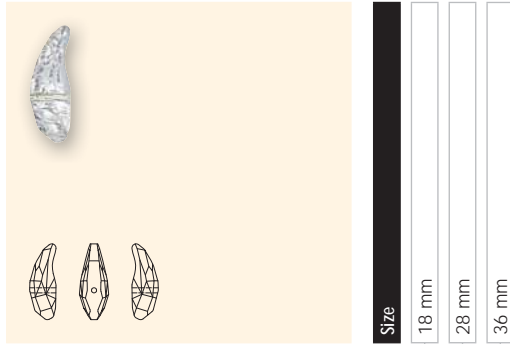

Colour	18 mm	28 mm	36 mm
Crystal (001)	■	■	■
Crystal Copper (001 COP)	■		
Crystal Golden Shadow (001 GSHA)	■	■	■
Crystal Moonlight (001 MOL)	■	■	■
Crystal Red Magma (001 REDM)	■	■	■
Crystal Silver Shade (001 SSHA)	■	■	■
Jet (280)	■	■	
Amethyst (204)	■	■	
Aquamarine (202)	■	■	
Black Diamond (215)	■	■	
Olivine (228)	■	■	
Light Amethyst (212)	■	■	
Light Topaz (226)	■	■	

## 5531 Aquiline Bead (top hole)\*

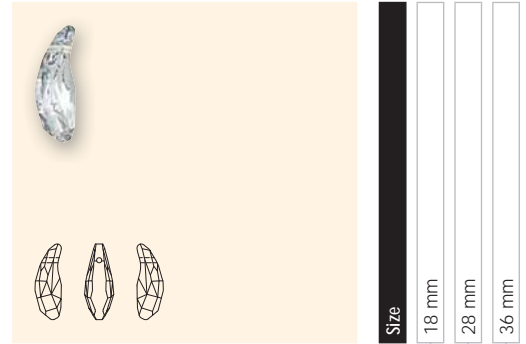

Colour	18 mm	28 mm	36 mm
Crystal (001)	■	■	■
Crystal Copper (001 COP)	■		
Crystal Golden Shadow (001 GSHA)	■	■	■
Crystal Moonlight (001 MOL)	■	■	■
Crystal Red Magma (001 REDM)	■	■	■
Crystal Silver Shade (001 SSHA)	■	■	■
Jet (280)	■	■	
Amethyst (204)	■	■	
Aquamarine (202)	■	■	
Black Diamond (215)	■	■	
Olivine (228)	■	■	
Light Amethyst (212)	■	■	
Light Topaz (226)	■	■	

\* For the combined use of art. 5530 and 5531 protective spacer rings (art. 7800 Nr. 646 + 647) are recommended. Please refer to the detailed information at the end of this chapter.

# Beads

## 5540 Artemis Bead

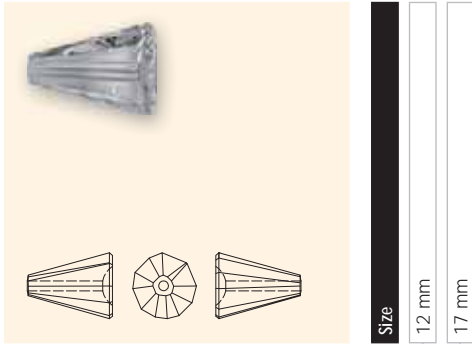

Size  
12 mm  
17 mm

Colour	
Crystal (001)	■ ■
Crystal AB (001 AB)	■ ■
Crystal Copper (001 COP)	■ ■
Crystal Golden Shadow (001 GSHA)	■ ■
Crystal Red Magma (001 REDM)	■ ■
Crystal Silver Shade (001 SSHA)	■ ■
Jet (280)	■ ■
Amethyst (204)	■ ■
Aquamarine (202)	■ ■
Black Diamond (215)	■ ■
Dark Indigo (288)	■ ■
Light Amethyst (212)	■ ■
Light Topaz (226)	■ ■
Olivine (228)	■ ■
Smoked Topaz (220)	■ ■

## 5556 Galactic Bead

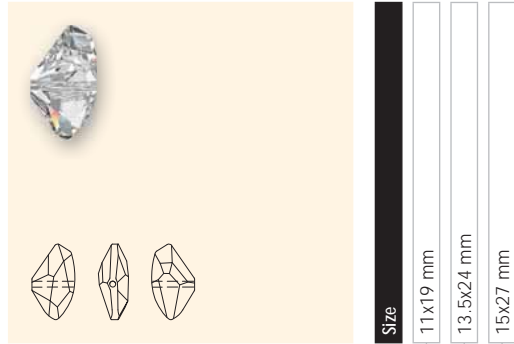

Size  
11x19 mm  
13.5x24 mm  
15x27 mm

Colour	
Crystal (001)	■ ■ ■
Crystal Copper (001 COP)	■ ■ ■
Crystal Golden Shadow (001 GSHA)	■ ■ ■
Crystal Moonlight (001 MOL)	■ ■ ■
Crystal Red Magma (001 REDM)	■ ■ ■
Crystal Silver Shade (001 SSHA)	■ ■ ■
Jet (280)	■ ■ ■
Aquamarine (202)	■ ■ ■
Jonquil (213)	■ ■ ■
Light Rose (223)	■ ■ ■
Peridot (214)	■ ■ ■
Tanzanite (539)	■ ■ ■
White Opal (234)	■ ■ ■

Beads

# Beads

## 5590 Wing Bead

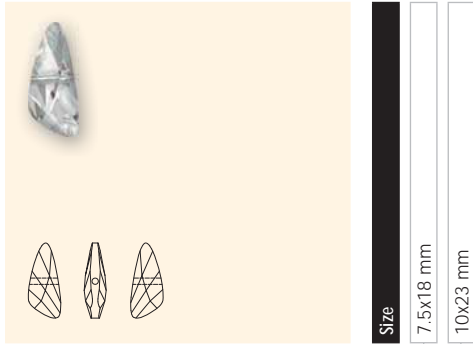

Colour		7.5x18 mm	10x23 mm
	Crystal (001)	■	■
	Crystal AB (001 AB)	■	■
	Crystal Copper (001 COP)	■	■
	Crystal Golden Shadow (001 GSHA)	■	■
	Crystal Red Magma (001 REDM)	■	■
	Crystal Silver Shade (001 SSHA)	■	■
	Jet (280)	■	■
	Aquamarine (202)	■	■
	Capri Blue (243)	■	■
	Fuchsia (502)	■	■
	Light Colorado Topaz (246)	■	■
	Light Rose (223)	■	■
	Light Topaz (226)	■	■
	Peridot (214)	■	■
	Provence Lavender (283)	■	■
	Tanzanite (539)	■	■

## 5600

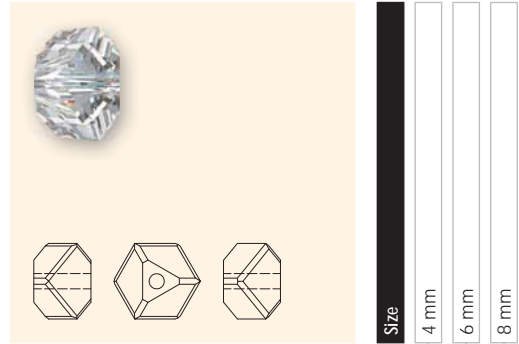

Colour		4 mm	6 mm	8 mm
	Crystal (001)	■	■	■
	Crystal AB B (001 ABB)	■	■	■
	Crystal Golden Shadow B (001 GSHAB)	■	■	■
	Jet (280)	■	■	■

# Beads

5601

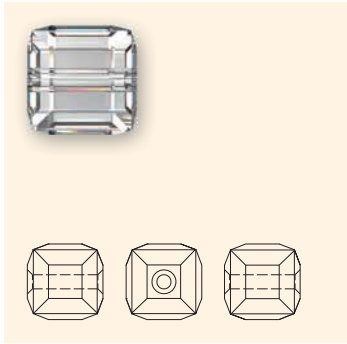

Size	4 mm	6 mm	8 mm	10 mm	12 mm
------	------	------	------	-------	-------

**Colour**

Crystal (001)	■	■	■	■	■
Crystal AB B (001 ABB)	■	■	■	■	■
Crystal Copper B (001 COPB)	■	■	■		
Crystal Golden Shadow B (001 GSHAB)	■	■	■		
Crystal Moonlight B (001 MOLB)		■	■		
Crystal Silver Shade B (001 SSHAB)	■	■	■		
Crystal Vitrail Medium B (001 VMB)	■	■	■		
Jet (280)	■	■	■		
Air Blue Opal (285)	■	■	■		
Amethyst (204)	■	■	■		
Amethyst AB B (204 ABB)		■	■		
Aquamarine (202)	■	■	■		
Aquamarine AB B (202 ABB)		■	■		
Black Diamond (215)	■	■	■		
Chrysolite (238)		■	■		
Cyclamen Opal (398)	■	■	■		
Dark Indigo (288)	■	■	■		
Emerald (205)	■	■	■		
Fern Green (291)	■	■	■		
Fuchsia (502)		■	■		
Greige (284)	■	■	■		
Indian Pink (289)	■	■	■		
Khaki (550)		■	■		
Light Amethyst (212)		■	■		
Light Colorado Topaz (246)	■	■	■		

5601



Size	4 mm	6 mm	8 mm	10 mm	12 mm
------	------	------	------	-------	-------

**Colour**

Light Grey Opal (383)	■	■	■		
Light Rose (223)	■	■	■		
Light Sapphire (211)	■	■	■		
Light Sapphire AB B (211 ABB)		■	■		
Light Siam (227)		■	■		
Light Topaz (226)		■	■		
Mint Alabaster (397)		■	■		
Mocca (286)	■	■	■		
Pacific Opal (390)		■	■		
Padparadscha (542)		■	■		
Palace Green Opal (393)	■	■	■		
Peridot (214)	■	■	■		
Peridot AB B (214 ABB)		■	■		
Provence Lavender (283)	■	■	■		
Purple Velvet (277)		■	■		
Rose (209)	■	■	■		
Rose AB B (209 ABB)		■	■		
Rose Water Opal (395)	■	■	■		
Sand Opal (287)	■	■	■		
Sapphire (206)	■	■	■		
Siam (208)	■	■	■		
Tanzanite (539)	■	■	■		
Tanzanite AB B (539 ABB)		■	■		
Topaz (203)	■	■	■		
White Alabaster (281)		■	■		

Beads

# Beads

## 5603 Graphic Cube Bead

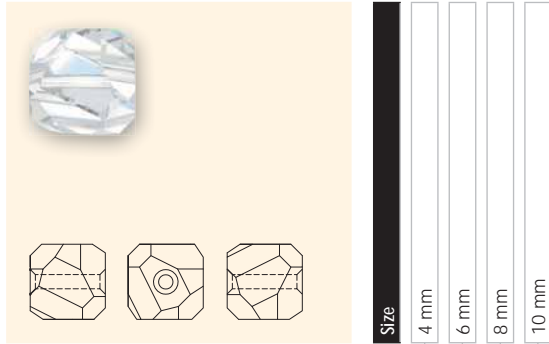

Colour	4 mm	6 mm	8 mm	10 mm
Crystal (001)	■	■	■	■
Crystal AB (001 AB)	■	■	■	■
Crystal Copper (001 COP)	■	■	■	■
Crystal Golden Shadow (001 GSHA)	■	■	■	■
Crystal Silver Shade (001 SSHA)	■	■	■	■
Jet (280)	■	■	■	■
Amethyst (204)	■	■	■	■
Aquamarine (202)	■	■	■	■
Black Diamond (215)	■	■	■	■
Light Amethyst (212)	■	■	■	■
Light Topaz (226)	■	■	■	■
Peridot (214)	■	■	■	■
Siam (208)	■	■	■	■
Topaz (203)	■	■	■	■

## 5650 Cubist Bead



Colour	12x8 mm	16x10 mm	20x13.5 mm	28x18.5 mm
Crystal (001)	■	■	■	■
Crystal AB (001 AB)	■	■	■	■
Crystal Copper (001 COP)	■	■	■	■
Crystal Golden Shadow (001 GSHA)	■	■	■	■
Crystal Moonlight (001 MOL)	■	■	■	■
Crystal Silver Shade (001 SSHA)	■	■	■	■
Jet (280)	■	■	■	■
Aquamarine (202)	■	■	■	■
Black Diamond (215)	■	■	■	■
Burgundy (515)	■	■	■	■
Light Amethyst (212)	■	■	■	■
Light Sapphire (211)	■	■	■	■
Peridot (214)	■	■	■	■

## 5621 Twist Bead

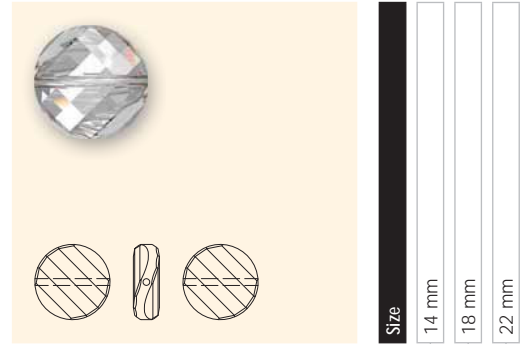

Colour	14 mm	18 mm	22 mm
Crystal (001)	■	■	■
Crystal Copper (001 COP)	■	■	■
Crystal Golden Shadow (001 GSHA)	■	■	■
Crystal Moonlight (001 MOL)	■	■	■
Crystal Red Magma (001 REDM)	■	■	■
Crystal Silver Shade (001 SSHA)	■	■	■
Jet (280)	■	■	■
Amethyst (204)	■	■	■
Aquamarine (202)	■	■	■
Black Diamond (215)	■	■	■
Jonquil (213)	■	■	■
Light Amethyst (212)	■	■	■
Light Colorado Topaz (246)	■	■	■
Light Rose (223)	■	■	■
Light Topaz (226)	■	■	■
Peridot (214)	■	■	■
Provence Lavender (283)	■	■	■
Sapphire (206)	■	■	■
Smoked Topaz (220)	■	■	■
Topaz (203)	■	■	■
White Opal (234)	■	■	■

# Beads

## 5714 Star Bead

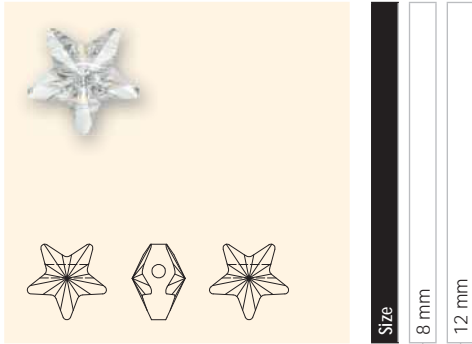

Colour		8 mm	12 mm
Crystal (001)		■	■
Crystal AB (001 AB)		■	■
Crystal Golden Shadow (001 GSHA)	New!	■	■
Crystal Red Magma (001 REDM)		■	■
Crystal Silver Shade (001 SSHA)		■	■
Jet (280)		■	■
Aquamarine (202)	New!	■	■
Black Diamond (215)	New!	■	■
Fuchsia (502)	New!	■	■
Jonquil (213)	New!	■	■

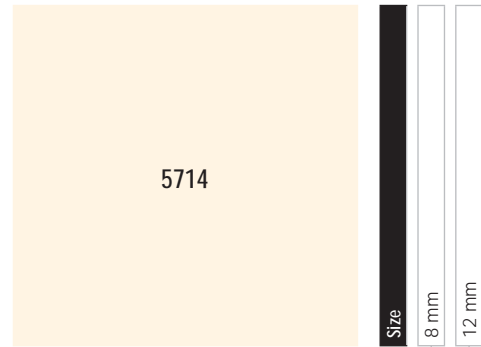

Colour		8 mm	12 mm
Light Amethyst (212)		■	■
Light Colorado Topaz (246)	New!	■	■
Light Rose (223)	New!	■	■
Light Sapphire (211)		■	■
Light Siam (227)	New!	■	■
Light Topaz (226)		■	■
Peridot (214)		■	■
Sapphire (206)	New!	■	■
Tanzanite (539)		■	■
Topaz (203)		■	■
Olivine (228)	New!	■	■

## 5727 Fish Bead

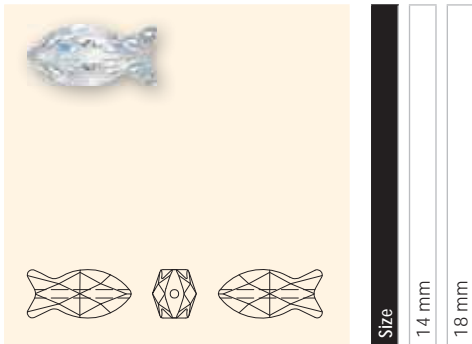

Colour		14 mm	18 mm
Crystal (001)		■	■
Crystal AB (001 AB)		■	■
Crystal Copper (001 COP)		■	■
Crystal Golden Shadow (001 GSHA)		■	■
Crystal Red Magma (001 REDM)		■	■
Crystal Silver Shade (001 SSHA)		■	■
Jet (280)		■	■
Aquamarine (202)		■	■
Capri Blue (243)		■	■
Indicolite (379)		■	■
Peridot (214)		■	■
Topaz (203)		■	■

# Beads

## 5742 Heart Bead

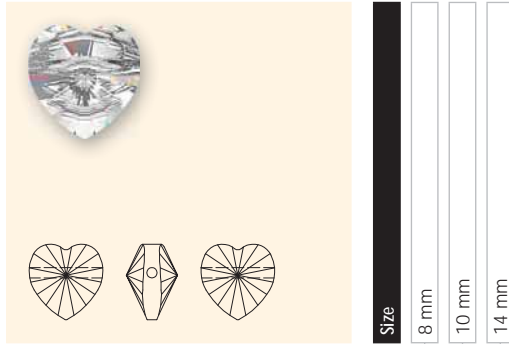

Colour	8 mm	10 mm	14 mm
Crystal (001)	■	■	■
Crystal AB (001 AB)	■	■	■
Crystal Golden Shadow (001 GSHA)	■	■	■
Crystal Red Magma (001 REDM)	■	■	■
Crystal Silver Shade (001 SSHA)	■	■	■
Jet (280)	■	■	■
Light Rose (223)	■	■	■
Siam (208)	■	■	■

## 5744 Flower Bead

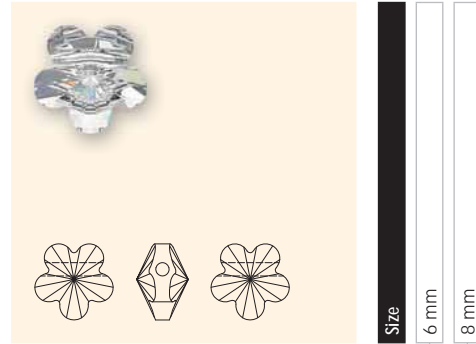

Colour	6 mm	8 mm
Crystal (001)	■	■
Crystal AB (001 AB)	■	■
Jet (280)	■	■
Aquamarine (202)	■	■
Fuchsia (502)	■	■
Jonquil (213)	■	■
Light Rose (223)	■	■
Peridot (214)	■	■
Violet (371)	■	■

## 5754 Butterfly Bead

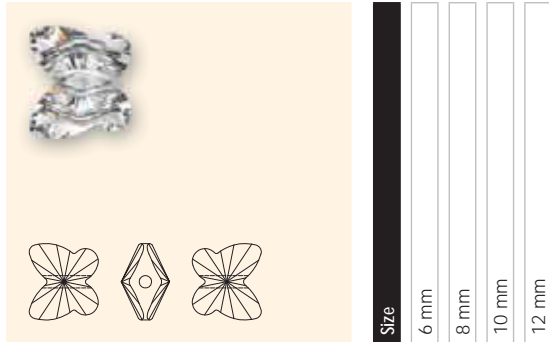

Colour	6 mm	8 mm	10 mm	12 mm
Crystal (001)	■	■	■	■
Crystal AB (001 AB)	■	■	■	■
Crystal Copper (001 COP)	■	■	■	■
Crystal Golden Shadow (001 GSHA)	■	■	■	■
Crystal Metallic Light Gold 2x (001 MLG2)	■	■	■	■
Crystal Red Magma (001 REDM)	■	■	■	■
Crystal Silver Shade (001 SSHA)	■	■	■	■
Jet (280)	■	■	■	■
Air Blue Opal (285)	■	■	■	■
Aquamarine (202)	■	■	■	■
Cyclamen Opal (398)	■	■	■	■

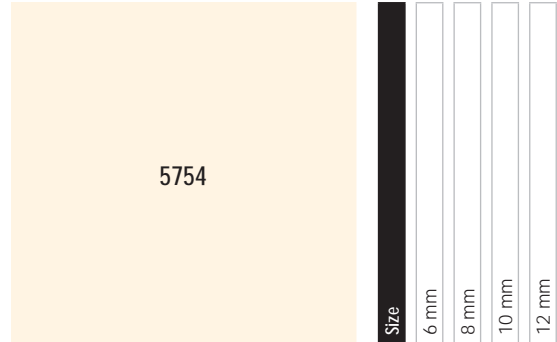

Colour	6 mm	8 mm	10 mm	12 mm
Fern Green (291)	■	■	■	■
Fuchsia (502)	■	■	■	■
Greige (284)	■	■	■	■
Jonquil (213)	■	■	■	■
Light Rose (223)	■	■	■	■
Light Siam (227)	■	■	■	■
Peridot (214)	■	■	■	■
Provence Lavender (283)	■	■	■	■
Violet (371)	■	■	■	■

These protective plastic spacer rings are recommended for the use in between Beads, as they facilitate the longevity of the designs and enable the utilisation of larger sized Beads and complex cuts. Please order art. 7800 Nr. 646 with sys.no. 977980 (packing unit = 100 pcs.) and art. 7800 Nr. 647 with sys.no. 977981 (packing unit = 1,000 pcs.).

### 7800 Protective Spacer Rings

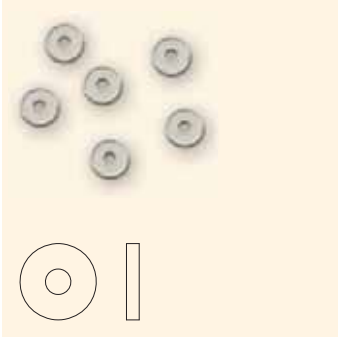

<b>C</b>	Transparent	
<b>S</b>	3 mm (hole 1 mm)	
<b>M</b>	100 PCS (Nr. 646)	
	1,000 PCS (Nr. 647)	150%

Article Size	Packing Unit = Minimum Order Quantity in Pieces	Average Net Weight in Gram per Packing Unit Crystal (001)	Average Gross Weight in Gram per Packing Unit Crystal (001)
<b>5000</b>			
2 mm	1,440	11.5	20.8
3 mm	720	23.6	33.4
4 mm	720	53.5	62.6
5 mm	720	105.3	116.3
6 mm	360	81.6	92.5
7 mm	288	126.2	159.2
8 mm	288	193.5	200.8
10 mm	144	180.6	199.4
12 mm	72	144.2	166.1
14 mm	72	247.1	280.5
16 mm	48	252.3	296.6
18 mm	24	168.7	185.9
20 mm	12	123.5	142.9
<b>5003</b>			
6 mm	360	109.9	120.8
8 mm	144	100.4	118.6
10 mm	144	195.9	219.2
12 mm	72	158.5	179.2
14 mm	48	172.4	193.0
16 mm	48	269.2	289.5
<b>5005</b>			
8 mm	216	145.4	172.1
12 mm	72	154.3	175.4
16 mm	24	122.1	146.7
<b>5015</b>			
3 mm	720	20.9	31.8
4 mm	720	55.9	66.8
<b>5020</b>			
4 mm	720	45.4	54.5
6 mm	360	74.5	85.2
8 mm	288	146.6	178.2
10 mm	144	116.4	139.2
12 mm	144	229.0	262.1
<b>5040</b>			
4 mm	720	41.3	50.4
6 mm	360	71.8	82.9
8 mm	288	135.6	163.7
12 mm	144	214.4	242.4
18 mm	24	121.4	140.2
<b>5041</b>			
12 mm	144	204.9	248.1
18 mm	24	114.2	133.0
<b>5139</b>			
12.5 mm	48	44.6	61.8
<b>5150</b>			
11x6 mm	216	100.2	125.6
15x7 mm	72	66.3	84.5
23x11 mm	36	120.5	146.5
<b>5180</b>			
14x14 mm	144	232.6	256.0

# Beads

Article Size	Packing Unit = Minimum Order Quantity in Pieces	Average Net Weight in Gram per Packing Unit Crystal (001)	Average Gross Weight in Gram per Packing Unit Crystal (001)
<b>5181</b>			
13x7 mm	144	72.3	94.6
17x9 mm	48	52.2	72.2
<b>5200</b>			
6x4 mm	360	44.1	53.2
7.5x5 mm	360	80.0	91.0
9x6 mm	144	56.7	67.6
<b>5203</b>			
12x8 mm	144	82.7	106.2
18x12 mm	72	151.9	177.9
<b>5205</b>			
15x6 mm	144	71.4	90.1
<b>5305</b>			
5 mm	720	52.7	63.9
6 mm	360	50.5	61.4
<b>5308</b>			
6 mm	360	54.4	65.4
8 mm	288	91.6	118.1
<b>5309/1</b>			
4 mm	1,440	99.0	110.3
6 mm	360	84.1	94.9
8 mm	288	166.3	186.5
<b>5328</b>			
2.5 mm	1,440	23.8	31.4
3 mm	1,440	34.1	45.2
4 mm	1,440	81.8	89.2
5 mm	720	89.3	100.0
6 mm	360	73.7	84.6
8 mm	288	141.8	173.4
10 mm	144	140.4	154.0
<b>5500</b>			
9x6 mm	144	59.0	69.9.0
10.5x7 mm	144	88.8	109.6
12x8 mm	144	144.0	164.1
18x12 mm	72	211.3	241.4
<b>5520</b>			
12 mm	144	154.4	178.9
18 mm	72	250.1	280.2
<b>5523</b>			
12 mm	144	143.2	173.6
16 mm	72	156.1	194.7
<b>5530</b>			
18 mm	72	71.1	89.3
28 mm	36	114.5	145.8
36 mm	24	194.9	227.8
<b>5531</b>			
18 mm	72	73.5	91.7
28 mm	36	135.6	163.6
36 mm	24	198.9	229.8
<b>5540</b>			
12 mm	72	62.1	86.7
17 mm	48	108.9	133.5

Ø Beads

# Beads

Article Size	Packing Unit = Minimum Order Quantity in Pieces	Average Net Weight in Gram per Packing Unit Crystal (001)	Average Gross Weight in Gram per Packing Unit Crystal (001)
<b>5556</b>			
11x19 mm	96	154.3	189.8
13.5x24 mm	36	111.5	135.0
15x27 mm	30	128.1	160.4
<b>5590</b>			
7.5x18 mm	108	85.9	134.3
10x23 mm	36	60.6	98.4
<b>5600</b>			
4 mm	288	44.2	65.4
6 mm	144	79.0	100.3
8 mm	144	192.1	211.3
<b>5601</b>			
4 mm	288	43.9	65.2
6 mm	144	70.6	88.9
8 mm	96	100.2	118.4
10 mm	72	138.0	156.5
12 mm	36	129.6	147.7
<b>5603</b>			
4 mm	288	34.7	58.6
6 mm	288	117.8	142.4
8 mm	144	119.3	138.6
10 mm	96	179.1	205.9
<b>5621</b>			
14 mm	96	168.7	202.1
18 mm	72	253.1	283.8
22 mm	24	142.6	159.8
<b>5650</b>			
12x8 mm	144	108.1	131.9
16x10 mm	72	138.0	153.9
20x13.5 mm	48	140.6	167.3
28x18.5 mm	12	97.4	123.6
<b>5714</b>			
8 mm	288	73.3	102.1
12 mm	108	72.3	102.2
<b>5727</b>			
14 mm	108	72.3	105.4
18 mm	72	114.5	138.2
<b>5742</b>			
8 mm	288	120.5	154.5
10 mm	288	233.1	266.5
14 mm	96	178.4	219.2
<b>5744</b>			
6 mm	360	47.4	58.1
8 mm	288	80.2	112.3
<b>5754</b>			
6 mm	360	42.3	53.0
8 mm	288	77.9	109.8
10 mm	288	156.9	188.9
12 mm	144	136.7	168.9
<b>7800</b>			
Nr. 646	100	-	-
Nr. 647	1,000	-	-

Photography: Christoph Sagel, Robert Striegl  
Content is subject to change without notice. Errors and misprints excepted.  
SWAROVSKI AG · P.O. Box 567 · 9495 Triesen · Liechtenstein

© 2010 Swarovski AG. All rights reserved. Partial or total publication, transmission, copy or other duplication of texts, graphics, pictures etc. which are to be found in this publication is forbidden without special consent by Swarovski AG.